

Kombi-Anbauelement 90

VE EK90A

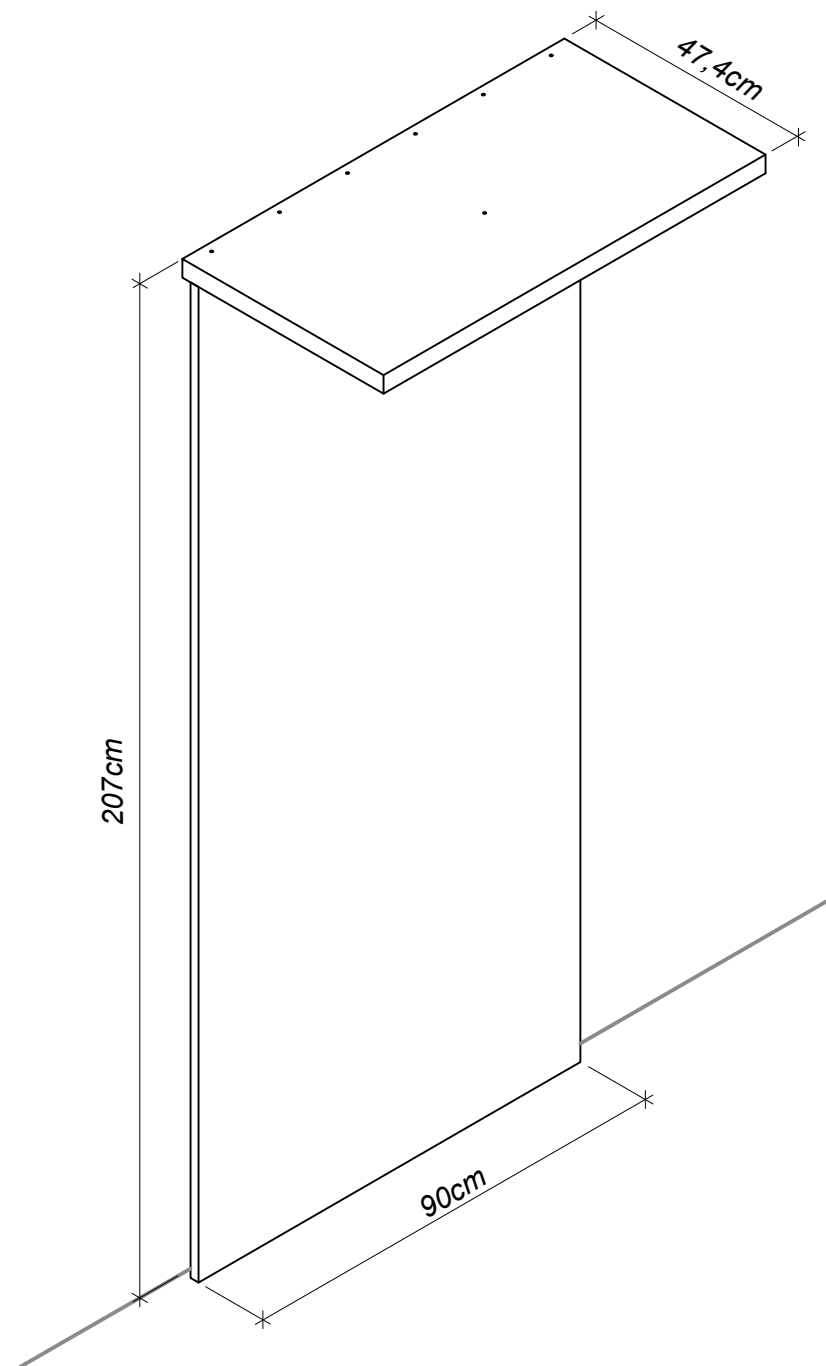

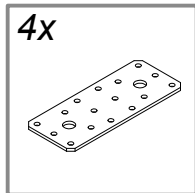

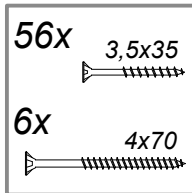
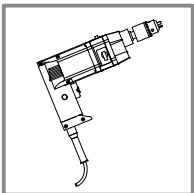
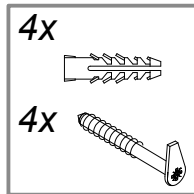
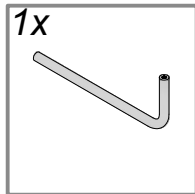
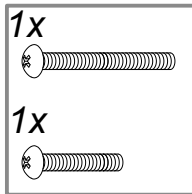
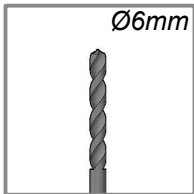
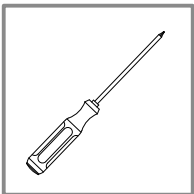
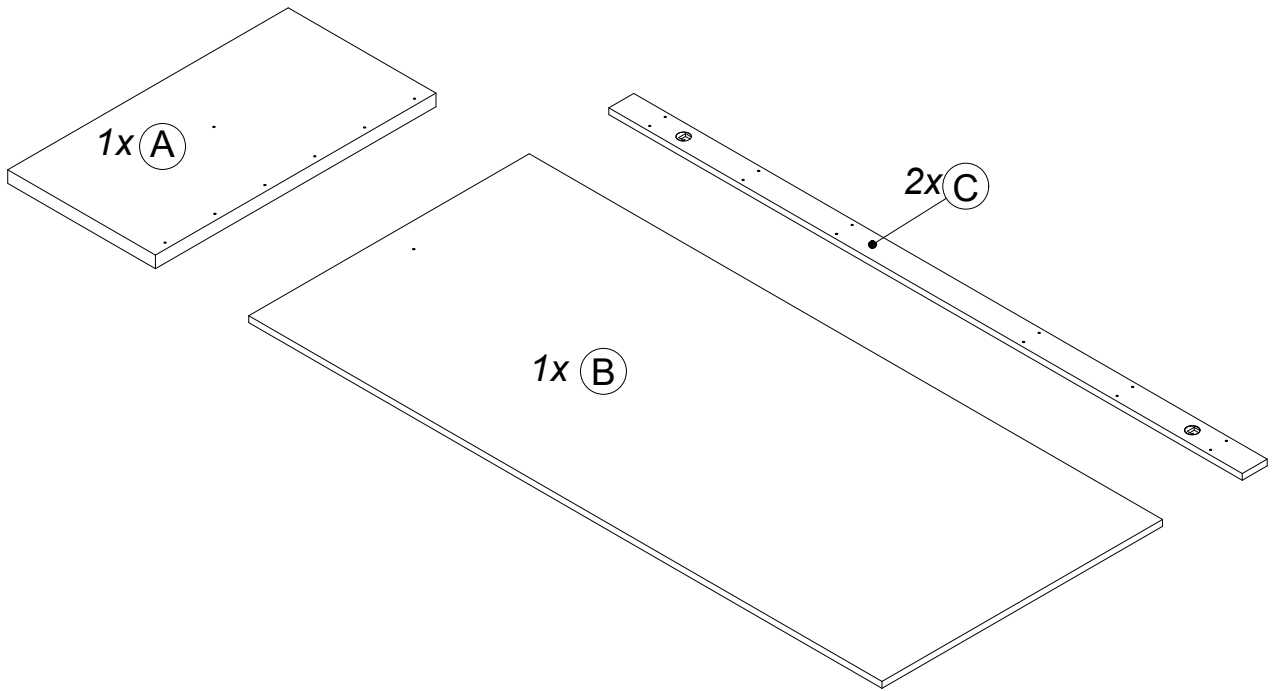
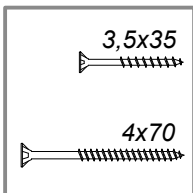
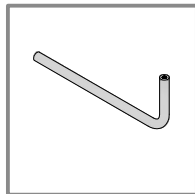
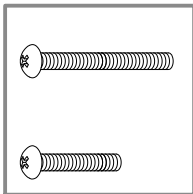
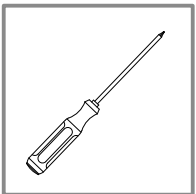
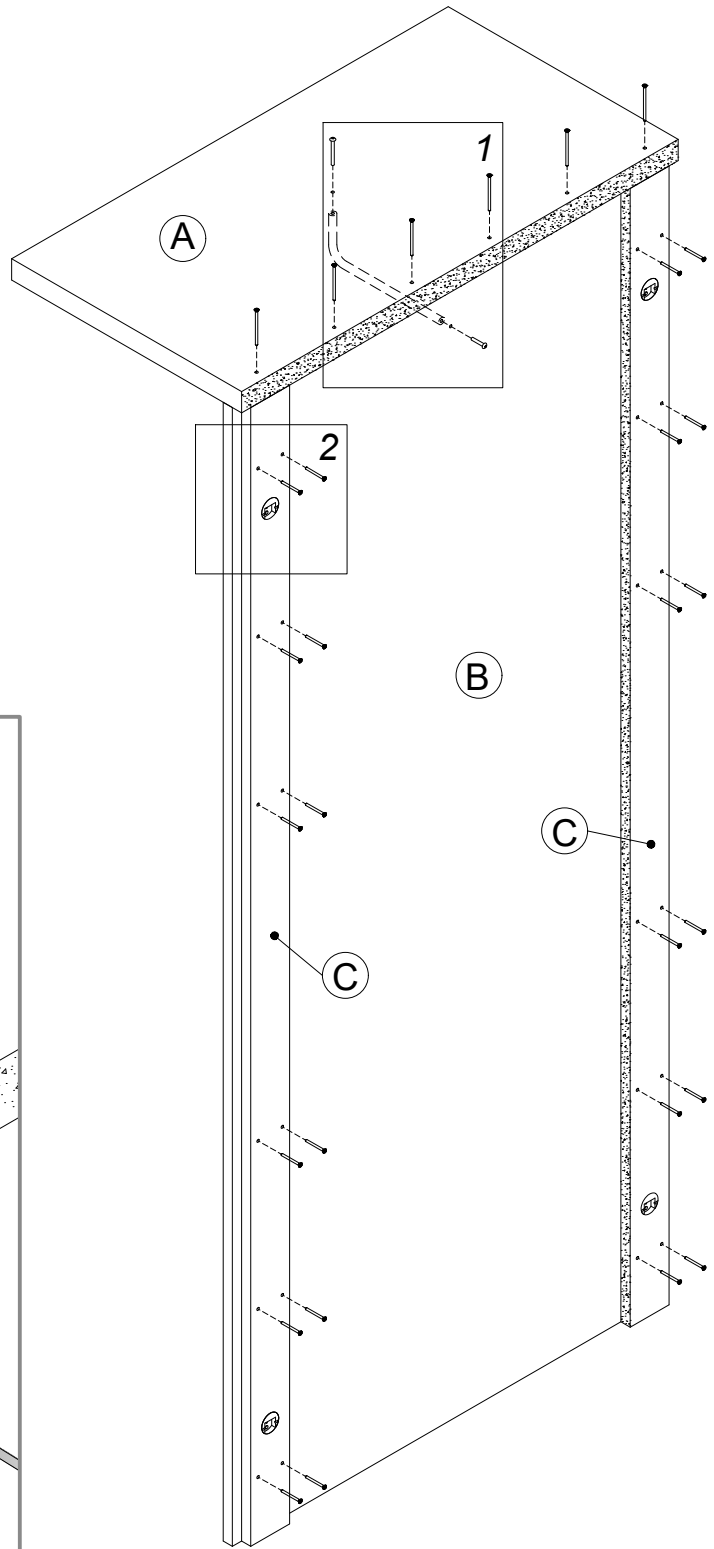
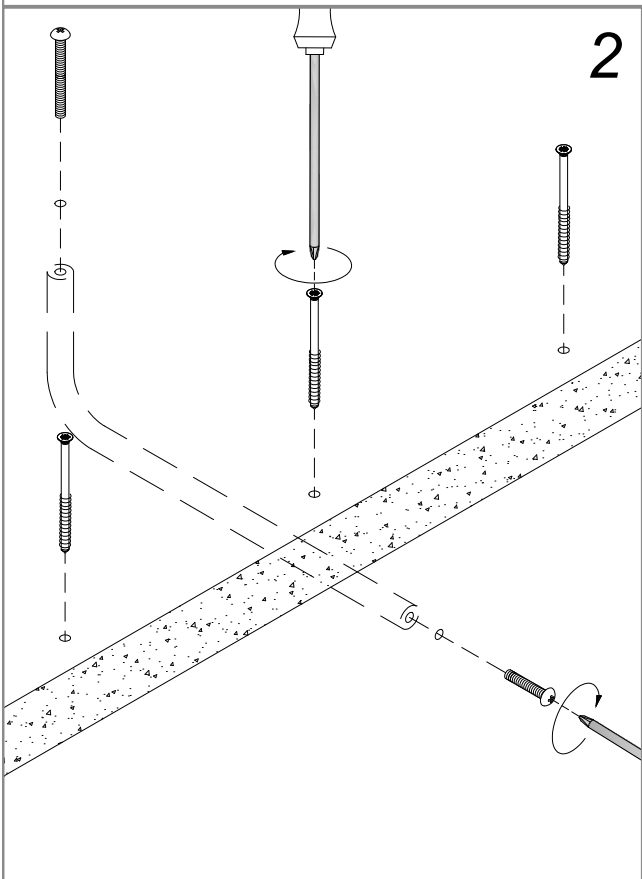
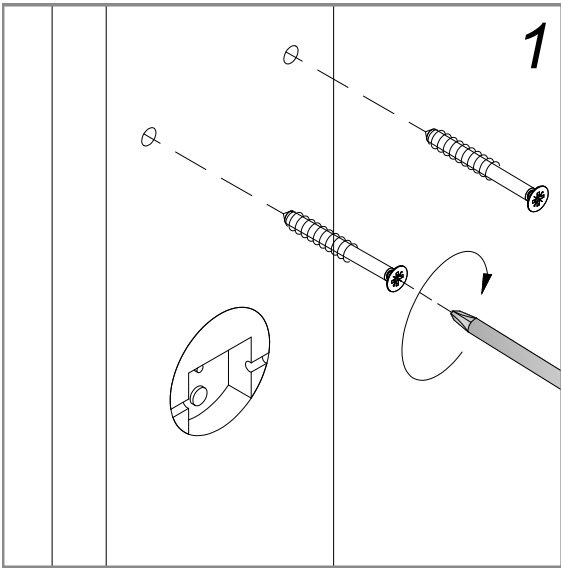

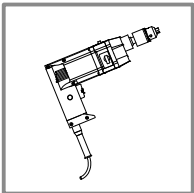
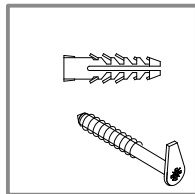
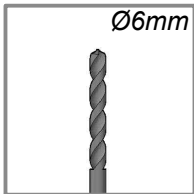
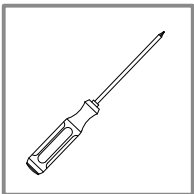
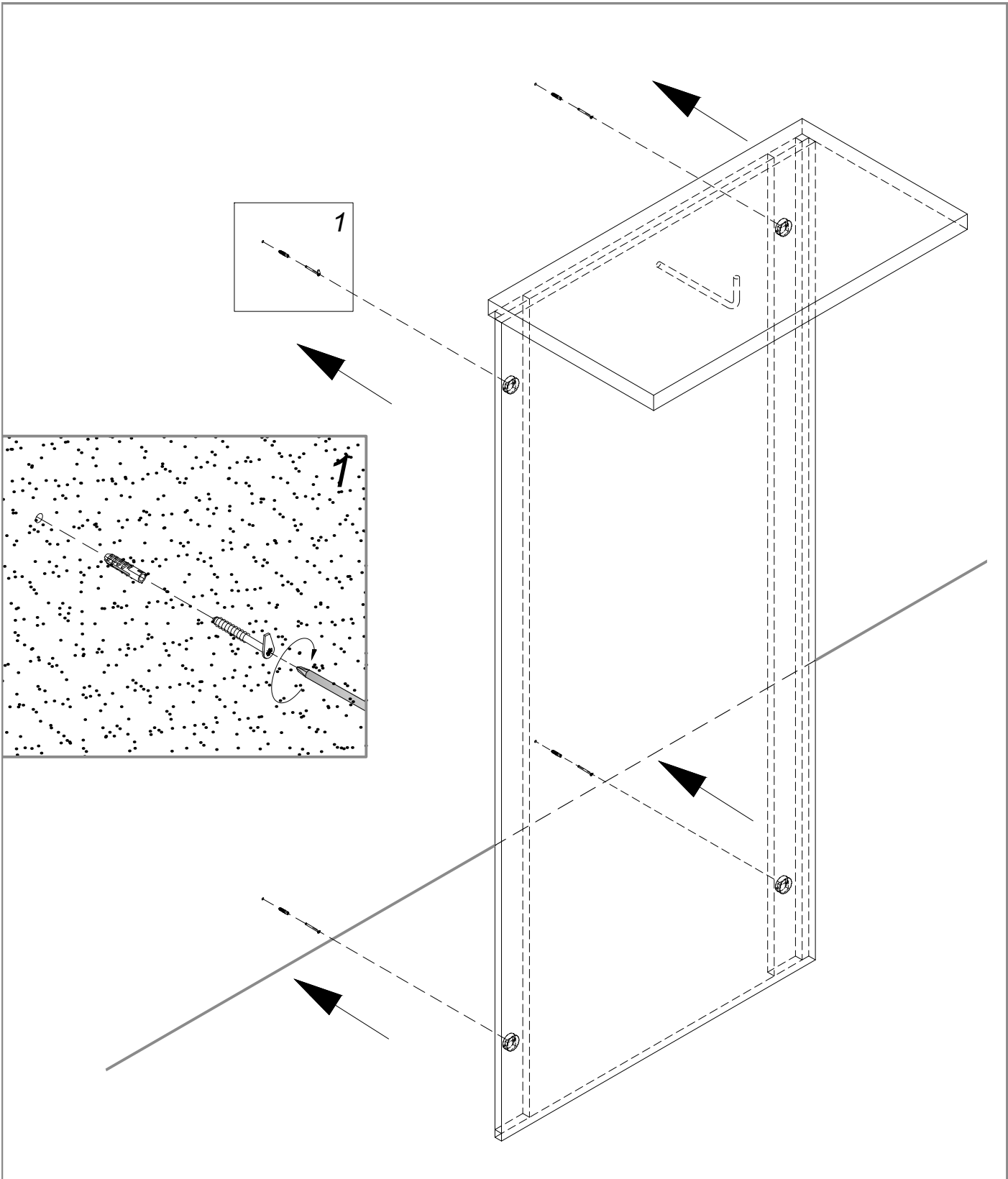

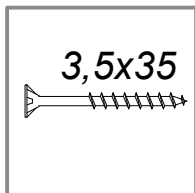
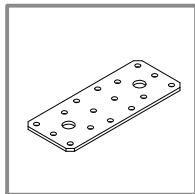
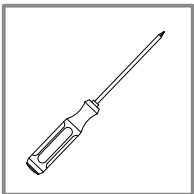
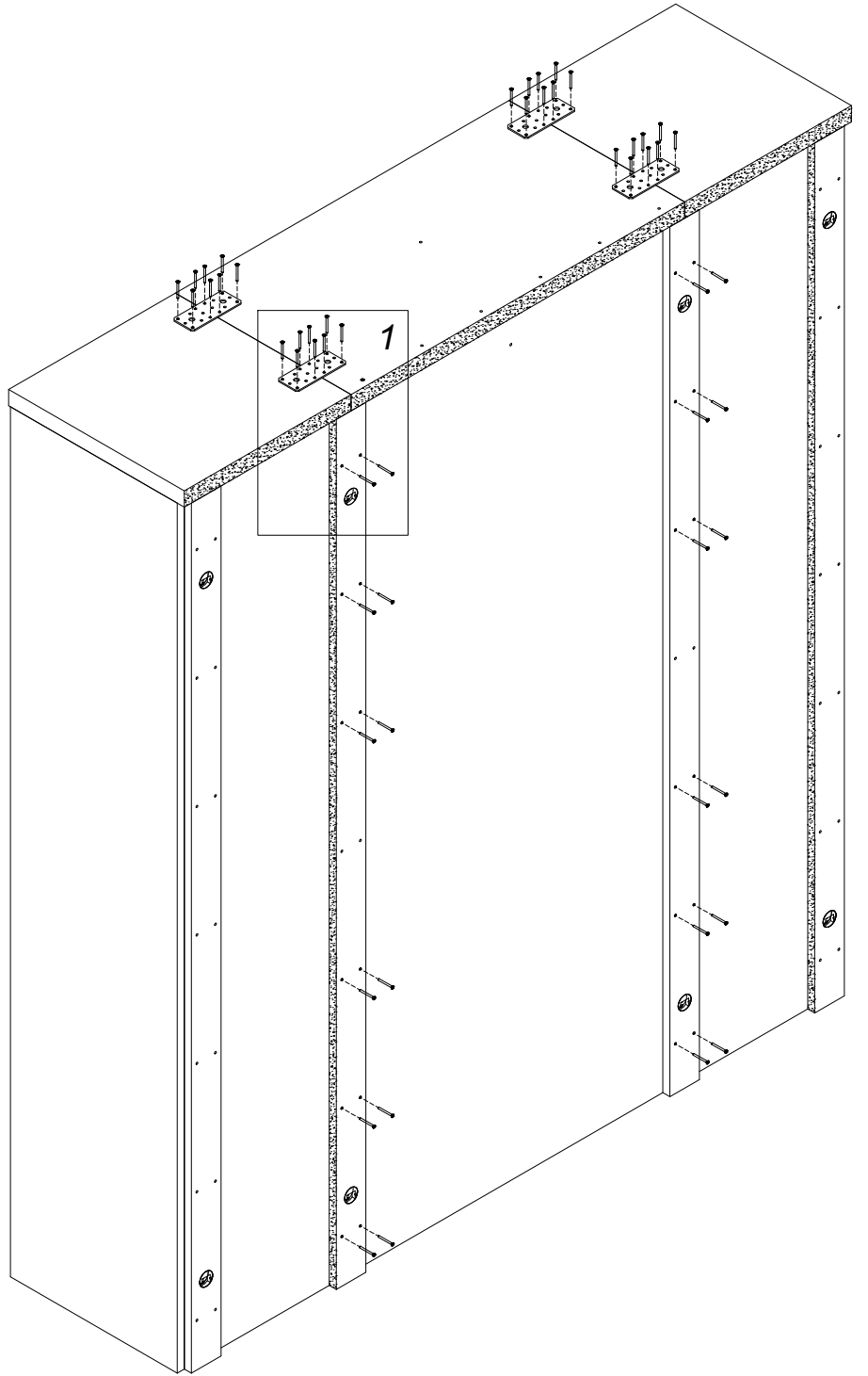
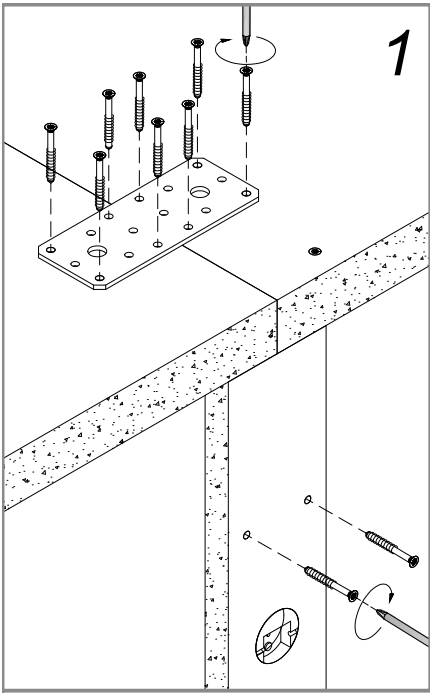

Montagehinweise / instructions for mounting / instructions de montage

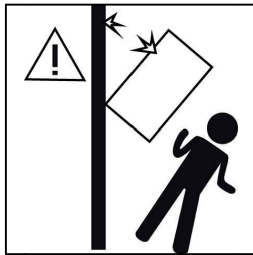

Gefahrenhinweis /
Danger!

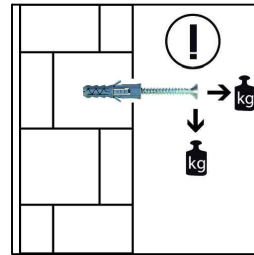

Geeignetes Befestigungsmaterial /
suitable fastening material /
matériel de fixation adapté

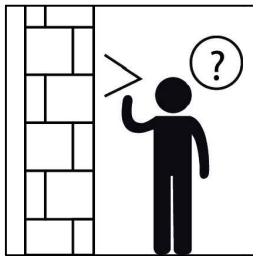

Wandbeschaffenheit prüfen /
check wall condition /
vérifier la structure du mur

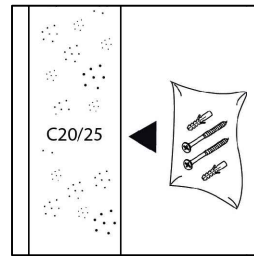

Mitgeliefertes Material für Beton C20/25 /
supplied material for concrete C20/25 /
matériel fourni pour le béton C20/25

Reinigungshinweise / instructions for cleaning / instructions de nettoyage

